

EZMarquee - 2 Lines 20 Characters (Outdoor)

2 Lines 20 Characters - NEMA 4X

The 2 Line 20 Char EZMarquee can hold up to a maximum of 20 characters (2") per line and features 2 lines of RED/Tri-Color LEDs. EZMarquees are enclosed in NEMA 4X extruded aluminum housing with NEMA ICS 2-230 level of electrical noise immunity.

All 2 Line 20 Character models are capable of communicating over RS232 and RS422/485 along with different models for Ethernet, DeviceNet and Profibus connectivity.

Characteristics:

Character Height:	2" / 4"
Characters per Line:	20 / 10
Number of Lines:	2 / 1
Visibility:	100' / 200'

2 Lines 20 Characters feature:

- 2 lines of 20 characters max
- Pre-matched LEDs
- 24 Hour Burn-In tested
- International Character Set
- Hang Mounting
- NEMA 4/4X Outdoor Housing
- NEMA ICS 2-230
- 110/220 VAC Power Input
- Surge Protection
- 100,000+ Hours Rated Life

See the different communication interface options available in the charts below



RED Outdoor



TRI color Outdoor

Model Number	Interface	Price	Del.
EZMR-2L20C-OUT	RS232 and RS422/485 only	\$1759	STK
EZMR-2L20C-E-OUT	Ethernet included	\$1959	3DAY
EZMR-2L20C-D-OUT	DeviceNet included	\$1959	3DAY
EZMR-2L20C-P-OUT	Profibus included	\$2039	3DAY

Model Number	Interface	Price	Del.
EZMT-2L20C-OUT	RS232 and RS422/485 only	\$1978	STK
EZMT-2L20C-E-OUT	Ethernet included	\$2179	3DAY
EZMT-2L20C-D-OUT	DeviceNet included	\$2179	3DAY
EZMT-2L20C-P-OUT	Profibus included	\$2259	3DAY

RED Outdoor Highbright

Model Number	Interface	Price	Del.
EZMRH-2L20C-OUT	RS232 and RS422/485 only	\$2639	STK
EZMRH-2L20C-E-OUT	Ethernet included	\$2939	3DAY
EZMRH-2L20C-D-OUT	DeviceNet included	\$2939	3DAY
EZMRH-2L20C-P-OUT	Profibus included	\$3059	3DAY

2 Lines 20 Characters Dimensions

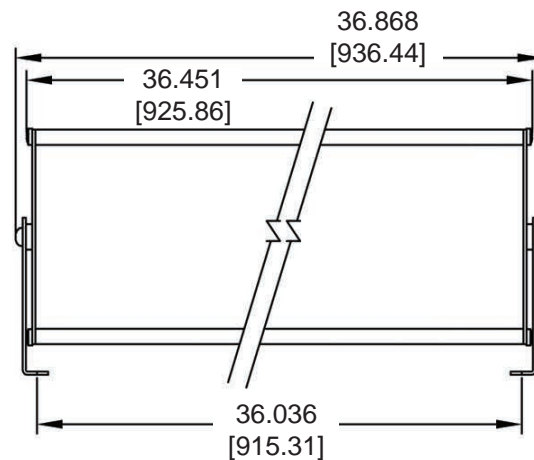
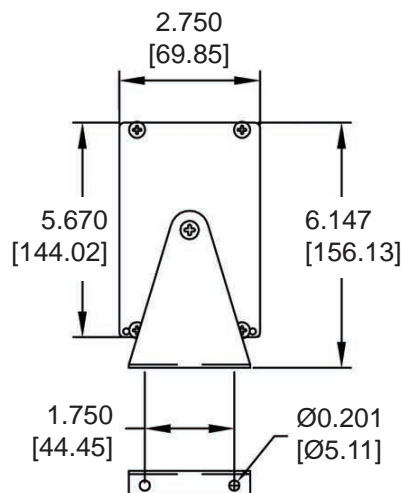

MOUNTING HOLE CENTERS



EZMarquee 2 Line 20 Character and 2 Line 40 Character Selection Guide and Specifications (Outdoor)

EZ Marquee Outdoor Model Specifications					
Part Number	EZMR-2L20C-OUT \$1759 EZMR-2L20C-E-OUT \$1959 EZMR-2L20C-D-OUT \$1959 EZMR-2L20C-P-OUT \$2039 EZMRH-2L20C-OUT \$2639 EZMRH-2L20C-E-OUT \$2939 EZMRH-2L20C-D-OUT \$2939 EZMRH-2L20C-P-OUT \$3059	EZMT-2L20C-OUT \$1978 EZMT-2L20C-E-OUT \$2179 EZMT-2L20C-D-OUT \$2179 EZMT-2L20C-P-OUT \$2259	EZMR-2L40C-OUT \$3199 EZMR-2L40C-E-OUT \$3399 EZMR-2L40C-D-OUT \$3399 EZMR-2L40C-P-OUT \$3459 EZMRH-2L40C-OUT \$4799 EZMRH-2L40C-E-OUT \$5099 EZMRH-2L40C-D-OUT \$5099 EZMRH-2L40C-P-OUT \$5199	EZMT-2L40C-OUT \$3798 EZMT-2L40C-E-OUT \$3999 EZMT-2L40C-D-OUT \$3999 EZMT-2L40C-P-OUT \$4059	
Display Type for Indoor	RED LED	TRI-Color LED	RED LED	TRI-Color LED	
Display Type for "H"	RED Sunlight Readable 8000 nits		RED Sunlight Readable 8000 nits		
Specification	2 Lines of 20 Char (2")		2 Lines of 40 Char (2")		
Max. Viewable Distance	200 Feet with 4" Characters				
Power Consumption	30 watts	55 watts	54 watts	100 watts	
Agency Approvals	UL, CUL, CE, pending				
Enclosure	NEMA 4/4X (Outdoor rated)				
Operating Temperature	-20° to 60° C Ambient				
Storage Temperature	-40° to 95° C Ambient				
Humidity	10% to 95% RH, Non-Condensing				
Input Power	110/220 VAC, 47-63Hz				
Electrical Interference	NEMA ICS 2-230 Showering Arc Test				
Electrical Tolerance	ANSI C37.90a-1974 (SWC) Surge With-Stand Capability Test				
Vibration	5 - 55 Hz 2G for 2 hours in the X, Y, and Z axis				
Shock	10G for under 12ms in the X, Y, and Z axis				
Serial Communications	Port 1 RS232; Port 2 RS422/485				
External Dimensions	36.1" x 11.7" x 2.8" (936.44 x 156.13 x 69.85mm)		72.1" x 5.4" x 2.8" (1831.31 x 106.35 x 69.85mm)		
Weight	8 lbs	8.5 lbs	15 lbs	16 lbs	